



XIV. Electrical / Electronics

Temperature Controllers

Mini Vehicle Controller



P/N: 35-0748



P/N: 35-8071

Specifications

Operating Voltage:	+9VDC to 32V DC
Operating Temperature:	-40°C to 85 °C (-40°F to 185°F)
Inputs:	5 Digital and 9 Analog
Outputs:	6 High side, 2 Bidirectional, 1 Analog and 2 PWM
Communication:	RS-485 and CANBus (J1939)

Electronic Climate Control



P/N: 35-0583



P/N: 35-0559

Temperature Controllers

Mini Vehicle Controllers

Specifications

Operating Voltage: +9VDC to 32V DC
 Operating Temperature: -40°C to 85 °C (-40°F to 185°F)
 Inputs: 5 Digital and 9 Analog
 Outputs: 9 Digital and 2 PWM
 Communication: RS-485 and CANBus (J1939)

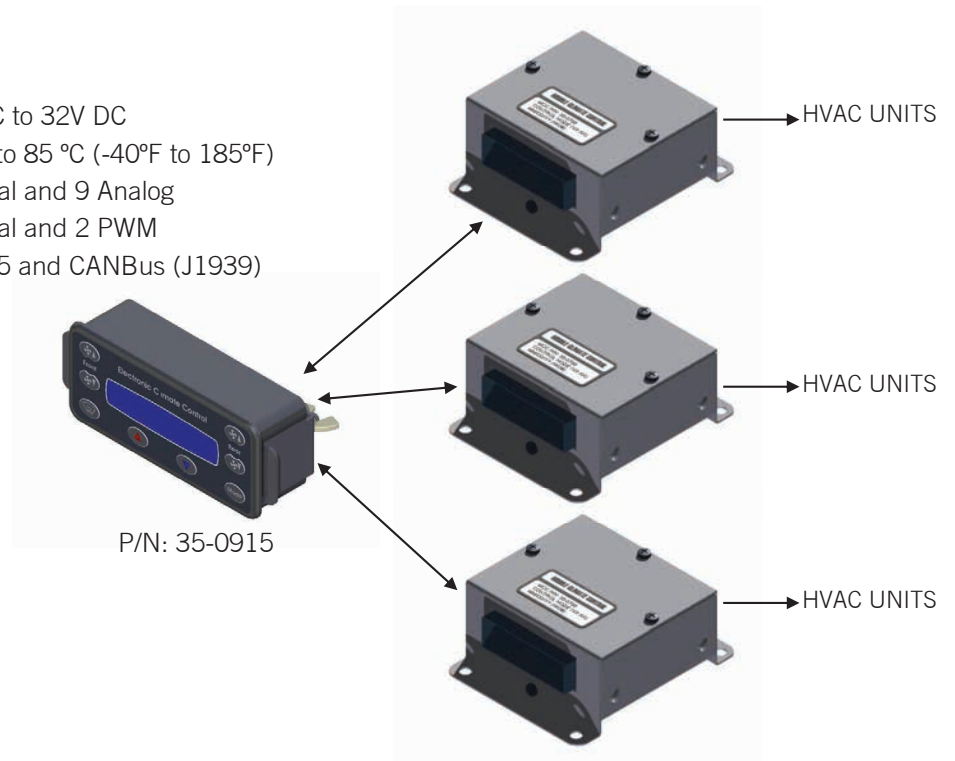

ECC/MVC Display

ECC Diagnostic Mode

Evap Time
12.5 Hrs. Rst->

Component running hours

Low Press. Sw.
0 Times Rst->

Pressure Switch Trips

Voltage
13.8V

Supply Voltage

Return Temp. 75°F
Open: 0 Short: 0 Rst->

Temperature Sensor Reading and errors

MVC Diagnostic Mode



Output Parameter Status



Component Error List

Defroster Controller



P/N: 35-0828

Data Logger

- Cabin set-point temperature
- Air sensor temperature readings and errors
- A/C compressor clutch cycle
- Battery supply voltage
- Refrigerant pressure
- Errors
- System current draw
- Differential air pressure
- Component total running hours
- Value of all input and outputs
- Evaporator blower speed
- Condenser fan speed
- Actuator position

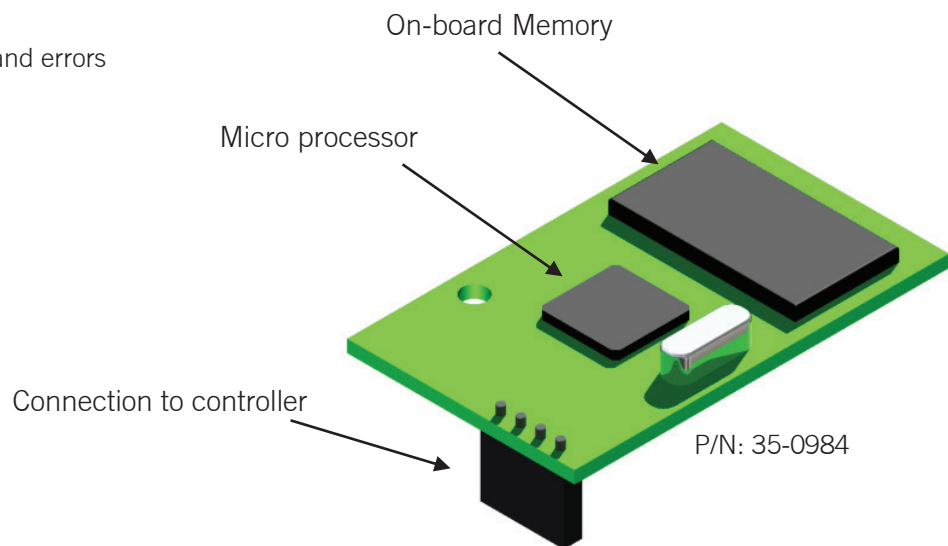

P/N: 35-0984

Control Panel with Automatic Temperature Control

The Automatic Thermostat Module (ATM) uses a temperature set-point potentiometer, motorized heater valve and temperature sensor to maintain driver cab temperature.

The operator will choose a temperature setting which will be maintained by automatically adjusting the heater valve with the Automatic Thermostat Module.

The ATM will improve cab temperature stability and provide a more comfortable operating environment.

The blower speed and evaporator coil temperature are controlled by the production proven blower switch and Deicing Module.

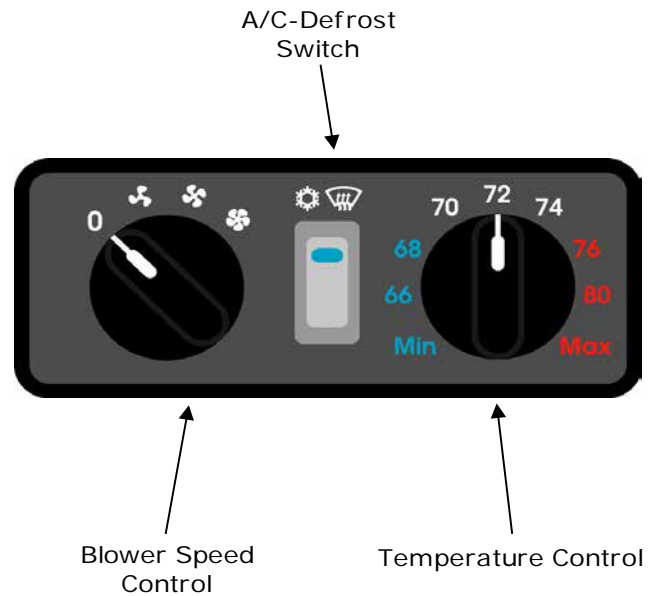

Automatic Thermostat Module



P/N: 35-0581

Specifications:

- Operating Voltage: 16VDC to 32VDC
- Storage Temperature: -40°C to +105°C (-40°F to 220°F)
- Operating Temperature: -40°C to +85°C (-40°F to 185°F)
- Controls Cabin temperature from 16° C (60.8°F) to 28° C (82.4°F)

Automatic Thermostat System

The Automatic Thermostat Module uses a microprocessor to calculate an appropriate position of the water valve to maintain cab temperature set-point.

There are two temperature sensors installed in this unit. The inside temperature sensor measures temperature of the air going to the unit. The after coil sensor measures the temperature of the air that is passing the heater coil. By measuring the after coil temperature the ATM can calculate the rate of temperature change of the discharge air of the HVAC unit.

With the measurement from the sensors, The module calculates the difference between inside and set-point temperature. From this difference, the thermostat module opens or closes the water valve accordingly.

When the temperature set-point potentiometer is turned to minimum temperature position, the water valve closes completely regardless of the inside temperature. This is the coldest setting. When the temperature set-point potentiometer is turned to the maximum temperature position, the water valve will open completely regardless of inside temperature. This is the hottest setting.

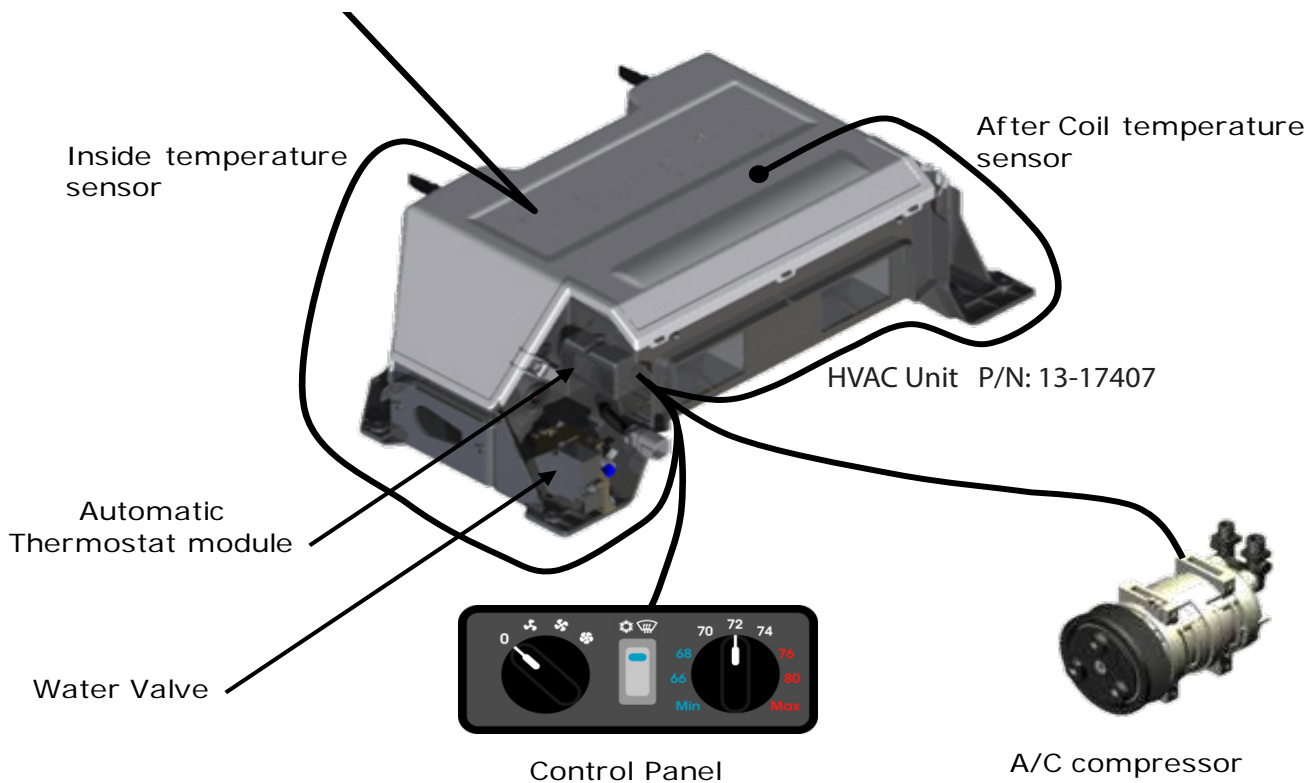

The Automatic Thermostat Module is protected against vibration & contaminants by polyurethane potting compound.

Multiplex Nodes



P/N: 35-0573

Specifications

Operating Voltage:	+9VDC to 32V DC
Operating Temperature:	-40°C to 85 °C (-40°F to 185°F)
Inputs:	6 Digital and 10 Analog
Outputs:	14 Digital and 2 PWM
Communication:	RS-485 and CANBus (J1939)



P/N: 35-0504

Specifications

Operating Voltage:	+9VDC to 32V DC
Operating Temperature:	-40°C to 85 °C (-40°F to 185°F)
Inputs:	6 Digital and 10 Analog
Outputs:	14 Digital and 2 PWM
Communication:	RS-485 and CANBus (1939)



P/N: 35-0811

Specifications

Operating Voltage:	+9VDC to 32V DC
Operating Temperature:	-40°C to 85 °C (-40°F to 185°F)
Inputs:	5 Digital and 9 Analog
Outputs:	6 High side, 2 Bidirectional, 1 Analog and 2 PWM
Communication:	RS-485 and CANBus (1939)

Basic ECC



P/N: 35-0070

Specifications

Operating Voltage: +9VDC to 32V DC
 Operating Temperature: -40°C to 85 °C (-40°F to 185°F)
 Inputs: 3 Digital and 4 Analog
 Outputs: 1 PWM and 3 Digital

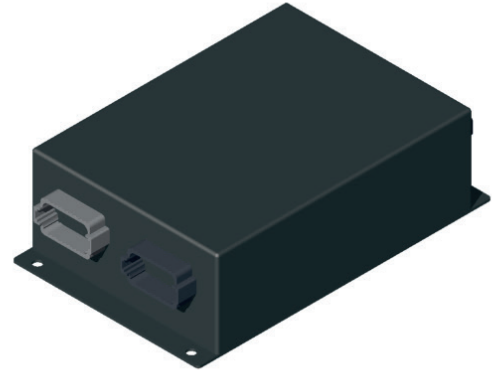

P/N: 35-0239

Specifications

Operating Voltage: +9VDC to 32V DC
 Operating Temperature: -40°C to 85 °C (-40°F to 185°F)
 Inputs: 7 Digital and 4 Analog
 Outputs: 10 Digital and 1 PWM
 Communication: RS-485

CANBus Controllers



P/N: 35-0549

Specifications:

Operating Voltage: 9VDC to 32VDC
 Storage Temperature: -40°C to +105°C
 Operating Temperature: -40°C to +85°C (-40°F to 185°F)
 Communication: CANBus, RS-485 (-40°F to 220°F)
 Microprocessor: 10MHz 64k Flash Processor 1k EEPROM



P/N: 35-0557

EcoTemp NG Display

The EcoTemp NG Display is developed to meet the demanding requirements of the motor coach and transit bus HVAC systems. The EcoTemp NG Driver Display was designed as a programmable platform that can be easily customised to suit customer requirements.

The large 2.5" x 1.5" OLED display offers wide viewing angle and is able to show text, graphics and full system messages for easy diagnostics. It has six configurable "soft keys" can be customized for basic or advance functions as per customer requirements.

During vehicle maintenance, service personnel can enter diagnostic mode by pressing preset sequence of buttons or using optional MCC Coolview via CAN Bus (J1939) connection. In this mode, errors stored in memory and real-time data of inputs and outputs are displayed for easy trouble shooting.

The industry leading OLED display with wide viewing angle supports unlimited graphics and text.

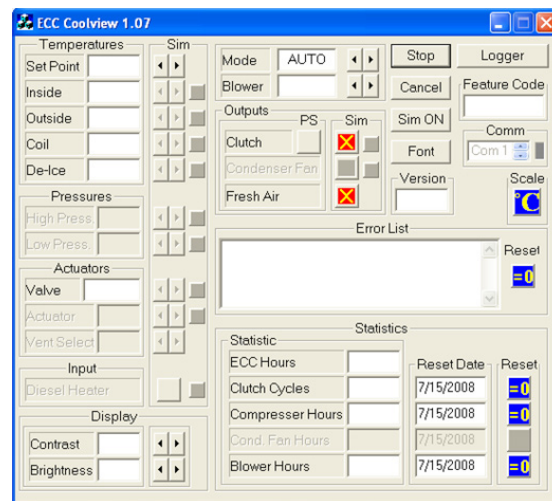

- 1- Temperature Set-Point
Adjust temperature for passenger compartment.
- 2- On/Off Button
Turns HVAC system On or Off
- 3- Cursor
Cursor and mode selection
- 4- Information
Displays system information

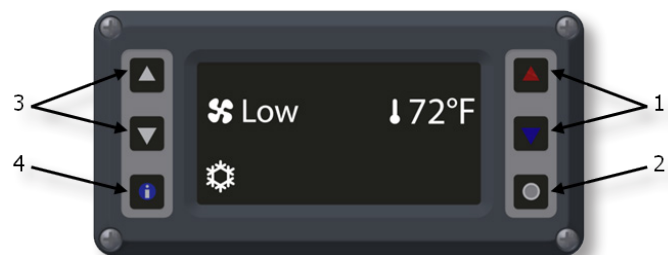

EcoTemp NG Display

The EcoTemp NG controller is developed to meet the demanding requirements of the motor coach and transit bus HVAC systems. The Bus HVAC Controller was designed as a programmable platform that can be easily customised to suit customer requirements.

FET". These MOS-FET have over current and temperature protection and have no moving parts. With built-in over current and temperature protection, it means less downtime due to controller failure.

During vehicle maintenance, service personnel can enter diagnostic mode by pressing preset sequence of buttons or using optional MCC Coolview via CAN Bus (J1939) connection. In this mode, errors stored in memory and real-time data of inputs and outputs are displayed for easy trouble shooting.



EcoTemp NG Controller				
Operating Voltage		+9V to 32V DC		
Operating Temperature		-40°C TO 85°C		
Inputs	23 Digital	12V or 24V DC	Cool, Heat, Defrost Vent, Auto and Off	
		12V or 24V DC	Condensor fan high/low	
		12V or 24V DC	Test Mode	
	11 Analog	10kΩ @ 25°C	3 Temperature Sensors	
		0 to 4.5V DC	High Pressure Sensor	
		0 to 4.5V DC	Low Pressure Sensor	
		0 to 10kΩ	Valve 1 Position Sensor	
		0 to 10kΩ	Valve 2 Position Sensor	
	5 Digital or Analog	0V to Supply Voltage		
Outputs	14 Digital	12V or 24V DC		
	4 H Bridge	12V or 24V DC		
	4 PWM	12V or 24V DC	25kHz	
Communication	RS 485			
	2 CanBus	J1939		
Micro Processor	Clock Speed	10MHz	64k Flash Processor 1k EEPROM	

EcoTemp Lite

The EcoTemp Lite is a HVAC control unit designed for on-road use. It has a simple and easy to use layout, it is ideal for motor coaches and transit buses. The easy to ready read LED display shows temperature settings,

blower speed or error display. The bus controller was designed as a programmable platform that could easily be expanded and customized. Several methods of compressor protection are available.



Features	Benefits
<ul style="list-style-type: none"> • Simple layout 	<ul style="list-style-type: none"> • Large display and buttons. Less driver distraction Keep drive's eyes on the road
<ul style="list-style-type: none"> • Small foot print 	<ul style="list-style-type: none"> • Takes up little space in dash board. Perfect for smaller size buses
<ul style="list-style-type: none"> • RS 485 and CAN BUS communication 	<ul style="list-style-type: none"> • New feature! Allows easy and fast dignostics. Able to upgrade HVAC system software while vehicle is running Less vehicle downtime
<ul style="list-style-type: none"> • Built-in diagnostics • Easy software upgrade • Optional coolview system monitoring software • Easy to use and install 	<ul style="list-style-type: none"> • Reduces maintenance, troubleshooting and minimise downtime

EcoTemp Lite

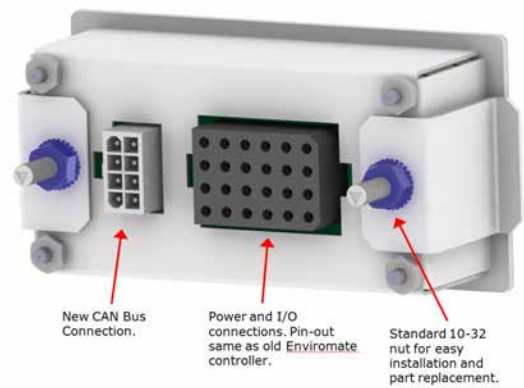
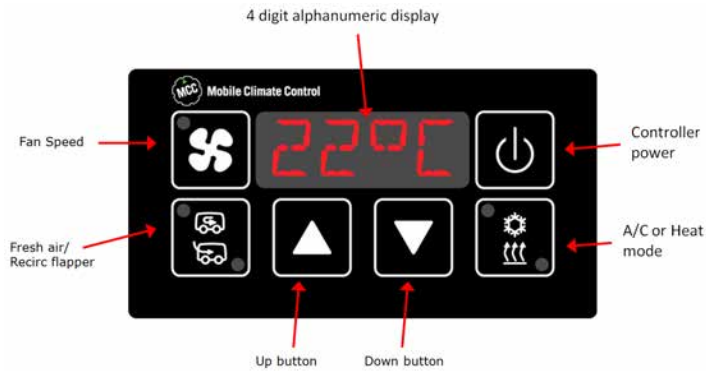
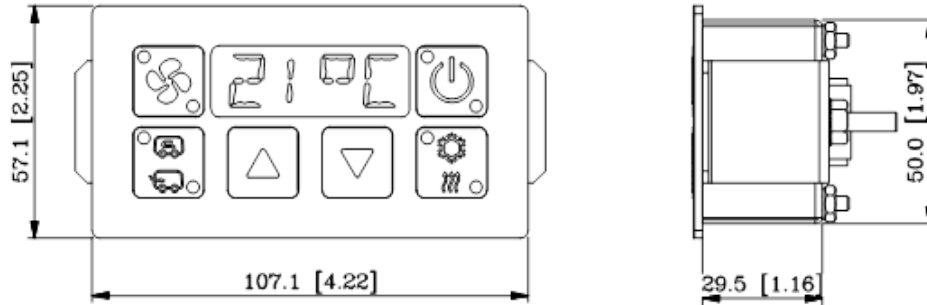

Technical Data

Operating Voltage	+9VDC to 32V DC
Operating Temperature	-40°C to 85 °C (-40°F to 185°F)
Inputs	5 Digital and 9 Analog
Outputs	10 High side, 1 Analog / PWM
Communication	RS-485 and CANBus (J1939)

Control Panels

26-0413 Control Panel 12V 26-0342 Control Panel 24V



No.	Part No.	Description
1	24-2213	Control Plate
2	28-0200	Overlay
3	25-0044	Blower Switch
4	26-0350	Rotary Control
5	25-0581	Knob
6	25-1105	Rocker Switch (G) 12V
	25-1106	Rocker Switch (G) 24V

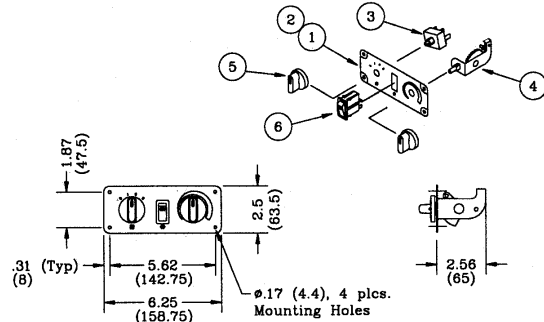

26-0445 Control Panel 12V 26-0446 Control Panel 24V



No.	Part No.	Description
1	24-2508	Control Plate
2	28-0245	Overlay
3	35-0036	Potentiometer Assy.
4	25-0581	Knob
5	25-1105	Rocker Switch (G) 12V
	25-1106	Rocker Switch (G) 24V

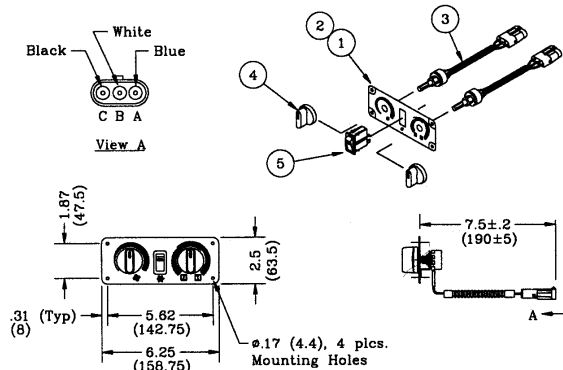

Connector Info: Connector 3-way Male Packard #12010717 with Male Terminal #12124582-L (3x) and Seal #12015323 (3x)

26-0415 Control Panel 12V 26-0416 Control Panel 24V



No.	Part No.	Description
1	24-2401	Control Plate
2	28-0224	Overlay
3	25-0044	Blower Switch
4	35-0036	Potentiometer Assy.
5	25-0581	Knob
6	25-1105	Rocker Switch (G) 12V
	25-1106	Rocker Switch (G) 24V

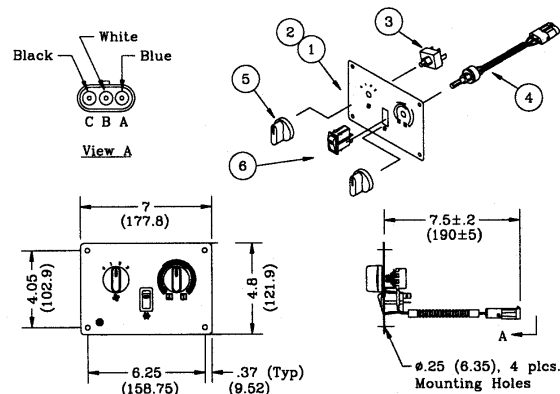

Connector Info: Connector 3-way Male Packard #12010717 with Male Terminal #12124582-L (3x) and Seal #12015323 (3x)

Control Panels

26-0387 Control Panel 12V

26-0386 Control Panel 24V

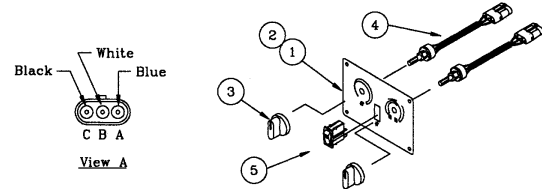

No.	Part No.	Description
1	24-3248	Control Plate
2	28-0223	Overlay
3	25-0581	Knob
4	35-0036	Potentiometer Assy.
5	25-1105	Rocker Switch (G) 12V
	25-1106	Rocker Switch (G) 24V

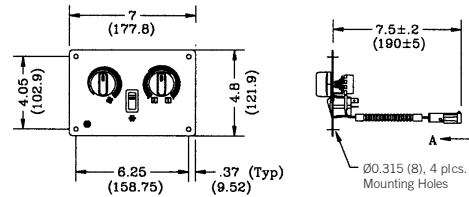

Connector Info: Connector 3-way Male Packard #12010717 with Male Terminal #12124582-L (3x) and Seal #12015323 (3x)

26-0398 Control Panel 12V

26-0444 Control Panel 24V



No.	Part No.	Description
1	24-2355	Control Plate
2	28-0215	Overlay
3	25-0581	Knob
4	25-0044	Blower Switch
5	26-0350	Rotary Control
6	25-1105	Rocker Switch (G) 12V
	25-1106	Rocker Switch (G) 24V

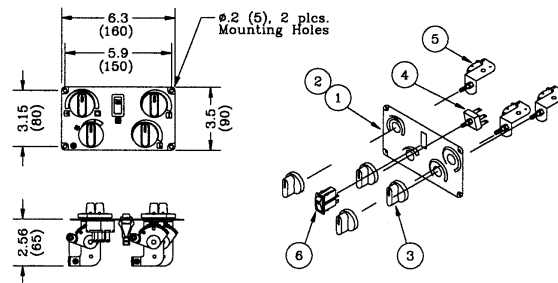

No.	Part No.	Description
1	24-2355	Control Plate
2	28-0163	Overlay
3	25-0581	Knob
4	25-0044	Blower Switch
5	26-0350	Rotary Control
6	25-0307	Switch On-Off
7	25-1105	Rocker Switch (G) 12V
	25-1106	Rocker Switch (G) 24V

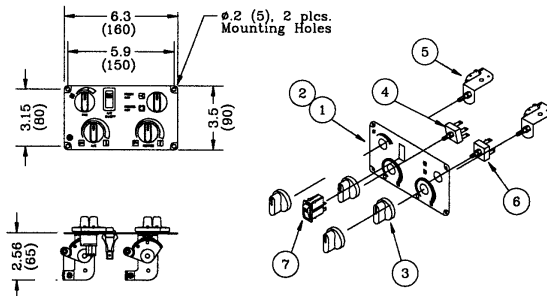

Control Panels

26-0361 Control Panel 12V
26-0362 Control Panel 24V

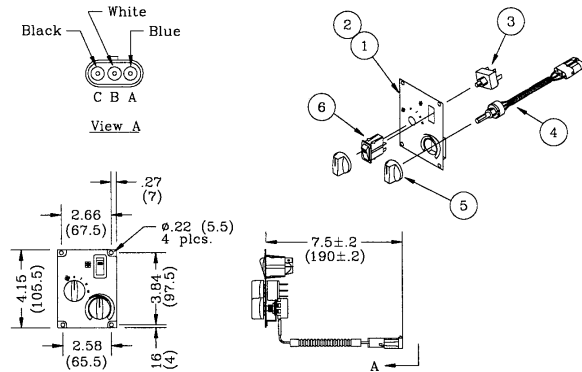

No.	Part No.	Description
1	24-2248	Control Plate
2	28-0214	Overlay
3	25-0044	Blower Switch
4	35-0036	Potentiometer Assy.
5	25-0435	Knob
6	25-1105	Rocker Switch (G) 12V
	25-1106	Rocker Switch (G) 24V



Connector Info: Connector 3-way Male Packard #12010717 with Male Terminal #12124582-L (3x) and Seal #12015323 (3x)

Control Panels

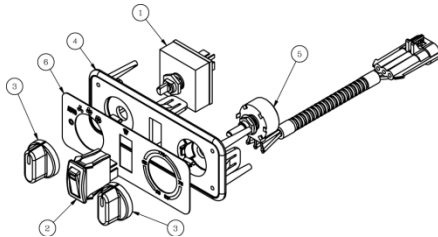
56-0093 Control panel 12V



No.	Part No.	Description
1	25-0857	Switch W/Nut
2	25-1105	Rocker Switch (G) 12V
3	25-2884	Knob Assembly
4	28-2005	Control Plate
5	35-1016	Potentiometer ASSY.
6	56-0095	Overlay

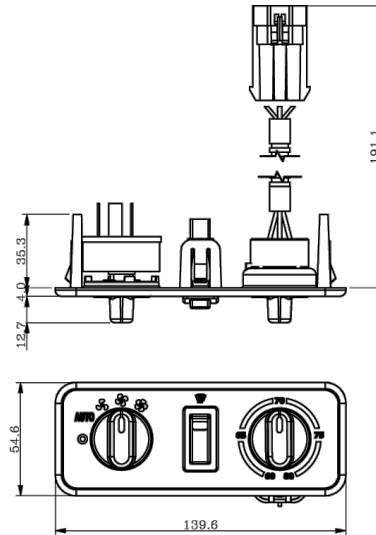

56-0079 Control panel 12V

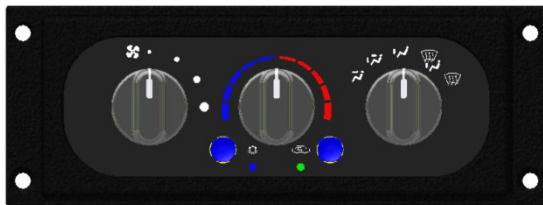

No.	Part No.	Description
1	25-0857	Switch W/Nut
2	25-2884	Knob Assembly
3	26-2018	Overlay
4	28-1988	Switch Holder
5	28-1989	Front Cover
6	28-1990	Rear Cover
7	31-1444	Connector
8	35-0989	Board Assembly

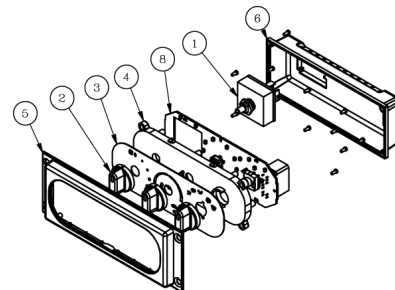
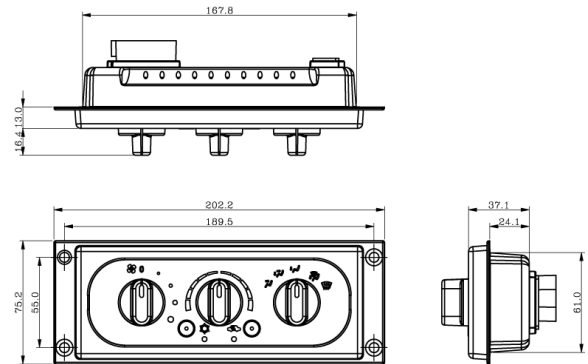

Temperature Sensors

Temperature sensors are an essential part of a automatic climate control system. These sensors send temperature information to the climate controller so set-point temperature can be maintained.

There are four types of sensors used in MCC HVAC systems.

- Device sensor is located near the evaporator coil to prevent the coil from freezing.
- Outside sensor is used to measure air temperature that is coming in to the HVAC unit's air inlet.
- Return air sensor is used to measure re-circulated air temperature.
- Inside sensor is used to measure cabin air temperature.

P/N: 35-0008



Deice Sensor

P/N: 35-0176



Inside Air Sensor

P/N: 35-0011



Outside Air Sensor



P/N: 35-0584

Return Air Sensor

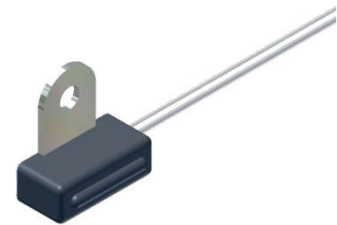

P/N: 35-0012

PWM Stepless Motor Drive

A Stepless Motor Drive Module controls motor speed by interrupting the current flow. The motor's speed is controlled by the duty cycle of output signal. At top speed (100% duty cycle), there is no current interruption. Without any moving parts, the power is delivered to the motor in "infinite" steps. A Stepless motor Drive allows more precise control, requires no maintenance and operates efficiently.

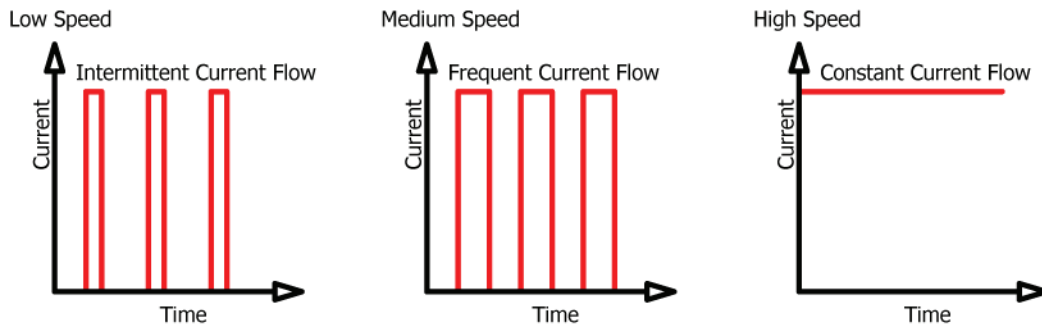

At low speed, current flow is switched on for a short time.

At high speed, current flow is not interrupted.

Standard Stepless Motor Drive

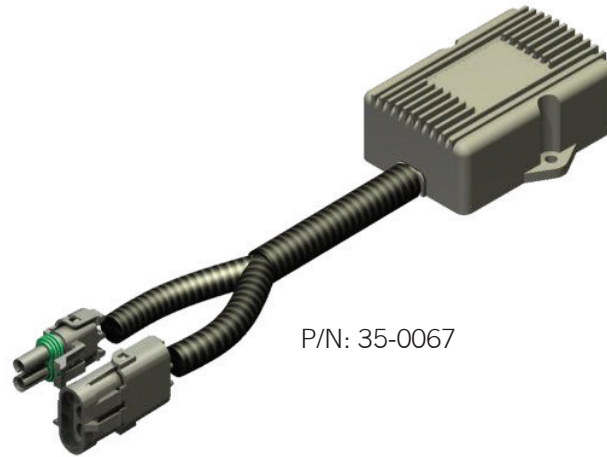

P/N: 35-0067

Specifications

Operating Voltage	: 9VDC to 32VDC
Storage Temperature:	-40°C to +105°C (-40°F to 220°F)
Operating Temperature:	-40°C to +85°C (-40°F to 185°F)
PWM Signal Input:	9V to 32V
Output:	300W

The Stepless Motor Drive Module is stand alone motor drive that uses an external PWM source to control blower's speed.

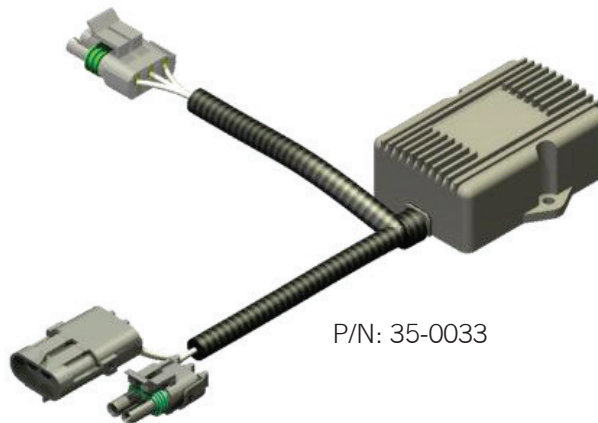

P/N: 35-0033

The Stepless Motor Drive Module uses a 10kΩ potentiometer to control the blower's speed.

Standard Stepless Motor Drive

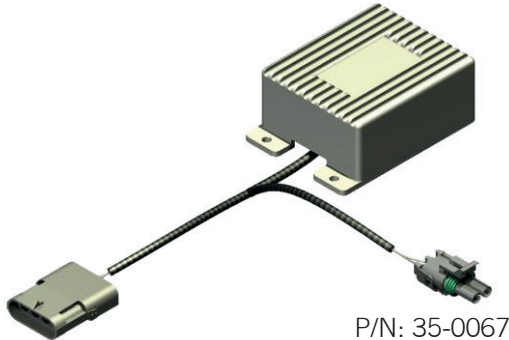

Specifications

Operating Voltage:	9VDC to 32VDC Storage
Temperature:	-40°C to +105°C (-40°F to 220°F)
Operating Temperature:	-40°C to +85°C (-40°F to 185°F)
PWM Signal Input:	9V to 32V
Output:	2700W

PWM Module with 400Hz input
Converts 400Hz PWM input signal to 25kHz output.

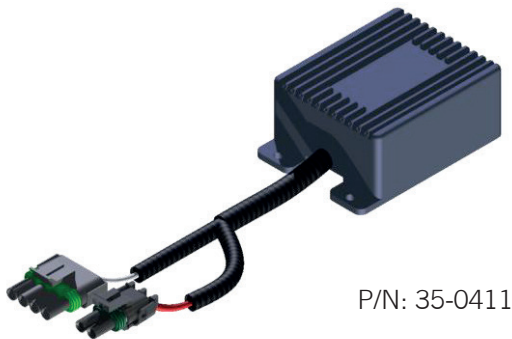

Specifications

Operating Voltage:	9VDC to 32VDC
Storage Temperature:	-40°C to +105°C (-40°F to 220°F)
Operating Temperature:	-40°C to +85°C (-40°F to 185°F)
PWM Signal Input:	9V to 32V (400Hz)
Output:	2700W



Brushless Motor Drives

Specifications

Operating Voltage:	16VDC to 27VDC
Storage Temperature:	-40°C to +105°C (-40°F to 220°F)
Operating Temperature:	-40°C to +85°C (-40°F to 185°F)
Signal Input:	0V DC to 5V DC
Output:	800W

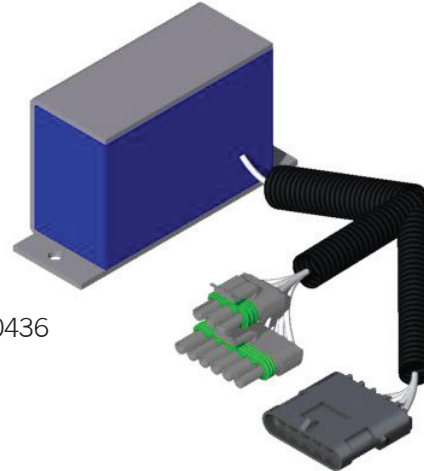

P/N: 35-0436

Brushless Motor Drive

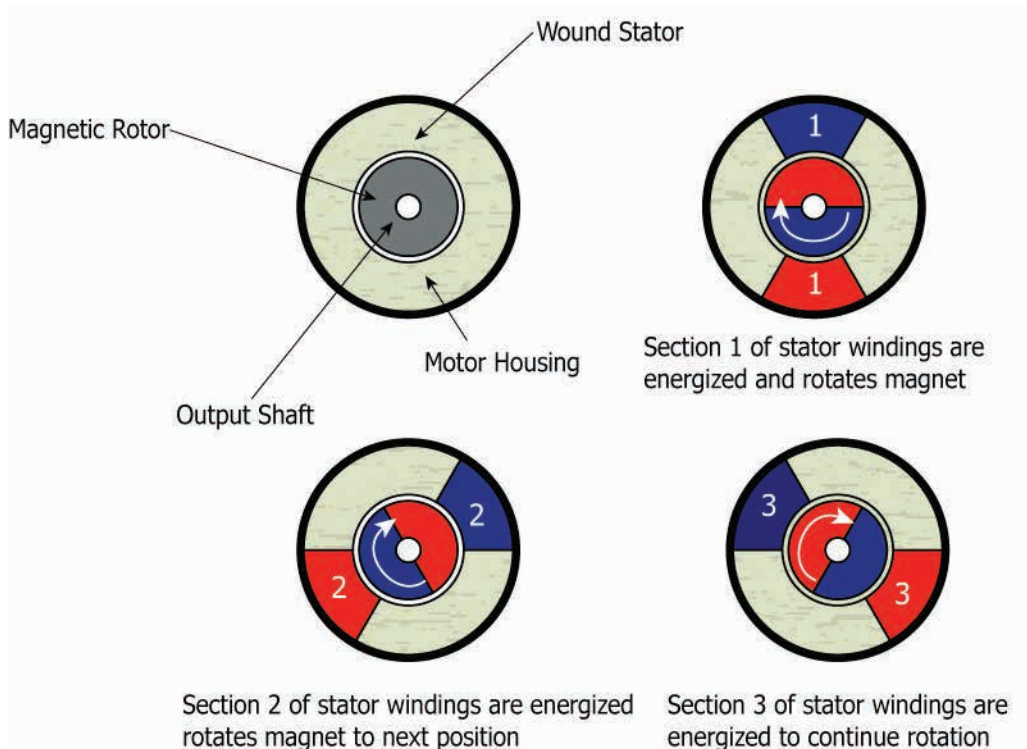

PWM Interface Module



P/N: 35-0569

Specifications:

Supply Voltage: 9V DC to 32V DC

Input Signal: PWM

Output Voltage: 0V DC to 10V DC



P/N: 35-0425

Specifications:

Supply Voltage: 9V DC to 32V DC

Input Signal: PWM

Output Voltage: 0V DC to 5V DC

Relays



P/N: 35-0625

Relay: 12V 30A (Fuse protected)
 Inputs: 10 Channel 500mA
 Outputs: 10 Channel Supply Switching 10A

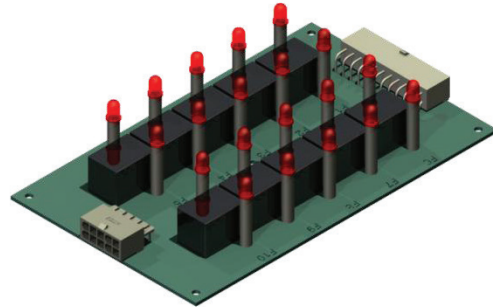

P/N: 35-0660

Relay: 24V 30A (Fused protected)
 Inputs: 8 Channel 24V 5A
 Outputs: 3 Channel 24V 20A
 2 Channel 12V 1A
 5 Channel Ground Switching 10A
 1 Channel Supply Switching 10A
 4 Channel for Actuator Flapper Door Control

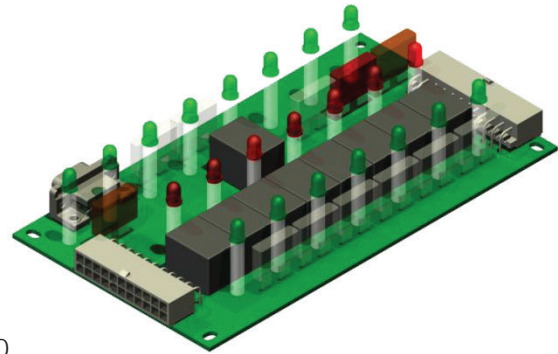

Relays

Relay: 12V/24V DC Fuse protected
 Inputs: 16 Channels Supply Switching 500mA
 Output: 10 Channel single output 20A
 2 Bus outputs 20A
 12V Output for Actuator
 Flapper door angle can be adjusted by resistor network.

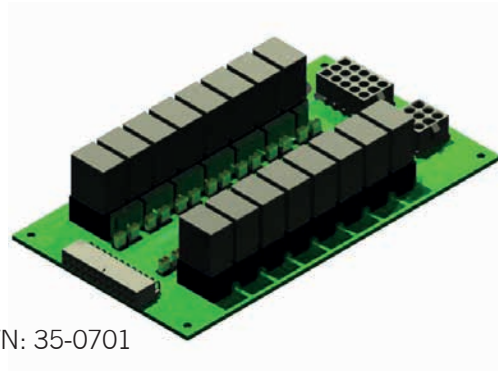

P/N: 35-0701

Relay: 12V DC/24V DC Fuse protected
 Inputs: 10 Channel Supply Switching 500mA
 Outputs: 6 Chanel Supply Switching 20A
 1 Ground Switching 20A

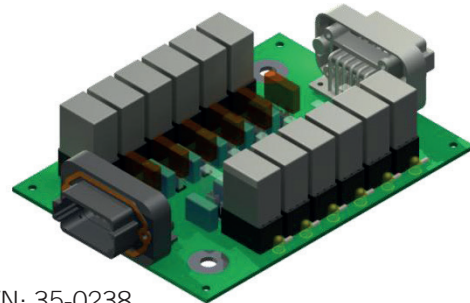

P/N: 35-0238

Relay: 12V DC/24V DC
 Inputs: 5 Channels 500mA
 Outputs: 3 Channel dual outputs 20A each
 1 Actuator output
 2 Channel bus

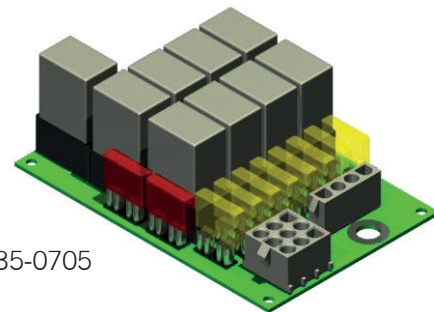

P/N: 35-0705

Relay: Solid state 12V/24V DC
 Inputs: 5 Ground Switching high impedance inputs 500mA
 2 PWM input
 Outputs: 6 Supply Switching Output (Fuse protected) 20A
 5 Low side output 20A
 Bused 10V PWM for 3 Blowers 20A
 Bused 5V PWM for 3 Condenser Fans 20A

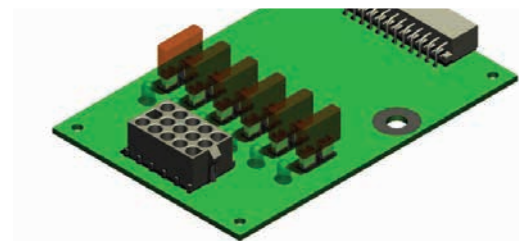

P/N: 35-0765

ECC Applications

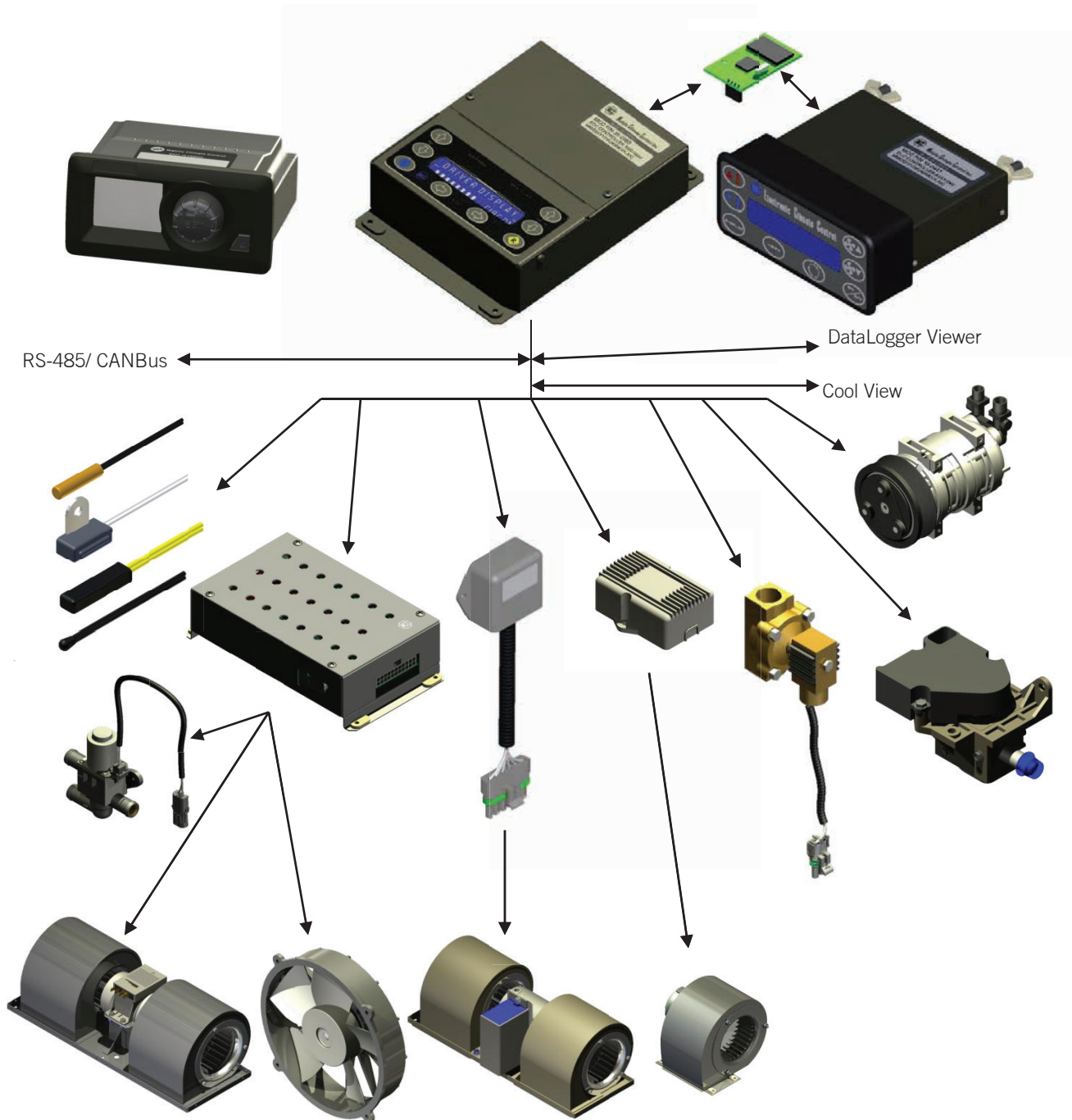

Multiplex Nodes Applications

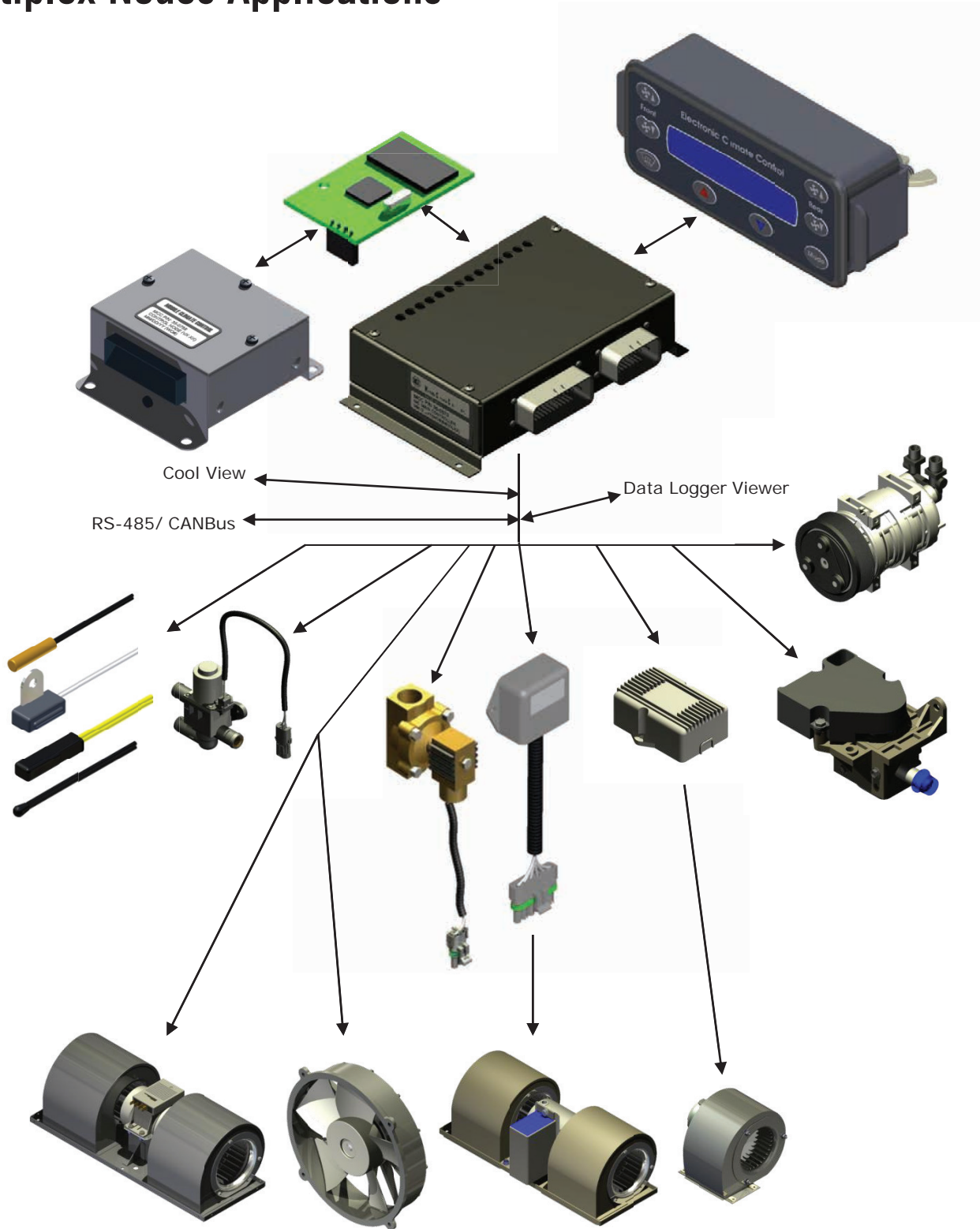

EasyTurn Family



P/N:35-0816

EasyTurn Defroster

The EasyTurn Defroster module is design to control driver defroster temperature from mini buses to highway coaches.



P/N: 35-0818

EasyTurn Convector

This module is design to control floor temperature in a passenger compartment in transit bus and highway coaches.



P/N: 35-0817

EasyTurn Compartment

The EasyTurn Compartment module is design to control temperature in passenger compartment in transit bus and highway coaches.



P/N 35-0815

EasyTurn ATM

The EasyTurn Automatic Temperature Module (ATM) ideal for controlling cabin temperature in mini-buses and off-road equipments.



P/N: 35-0821

EasyTurn Fan control



P/N: 35-0822



P/N: 35-0825

EasyTurn A/C

The EasyTurn A/C Module controls A/C compressor and fan speed for fresh and recycled air. It is ideal for off-road and high-way applications.

Features:

- CANBus ready
- Flash memory – easily reprogrammable
- Designed to control interior climate in mini bus to full size bus
- Integrated backlighting
- Easy to install

Automatic Thermostat Module

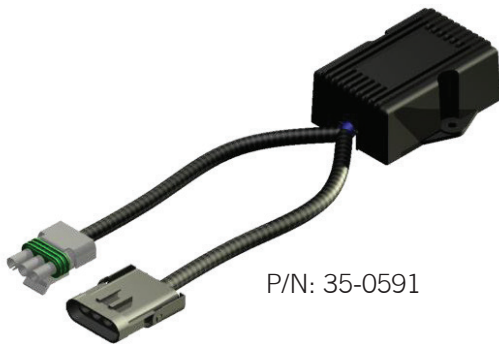

P/N: 35-0591

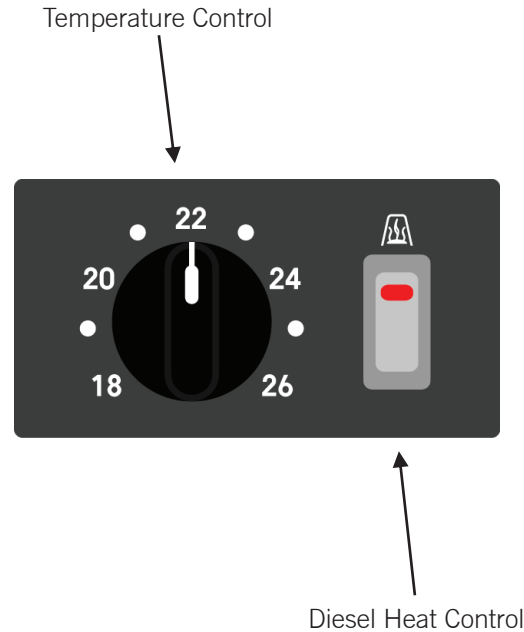

Specifications:

- Operating Voltage: 16VDC to 32VDC
- Storage Temperature: -40°C to +105°C (-40°F to 220°F)
- Operating Temperature: -40°C to +85°C (-40°F to 185°F)
- Controls Cabin temperature from 16° C (60.8°F) to 28° C (82.4°F)

Electronic De-icing Thermostat



P/N: 35-0709

- Specifications: 9VDC to 32VDC
- Operating Voltage: Cut in: +2°C ±0.4°C
- Cut in/Cut out Temperature: Cut out: -2°C ±0.4°C
- Temperature
- Storage Temperature: -40°C to +105°C (-40°F to 220°F)
- Operating Temperature: -40°C to +85°C (-40°F to 185°F)
- Clutch: 7A

Electronic De-icing Thermostat (EDT)

1. Description

The MCC Electronic De-icing Thermostat (EDT) is a microcontroller based module that measures evaporator coil temperature and cycles the compressor clutch to maintain a constant evaporator coil temperature. Onboard temperature sensor diagnostics are also built into the module. The EDT is very compact and with the same foot print as the older mechanically operated thermostats.

2. Basic Operation

If the EDT does not detect any temperature sensor failure, it will turn the compressor clutch and status light on when the evaporator coil temperature is above +2°C. When the evaporator coil temperature is below -2°C, the EDT will turn off the compressor clutch output and status light.

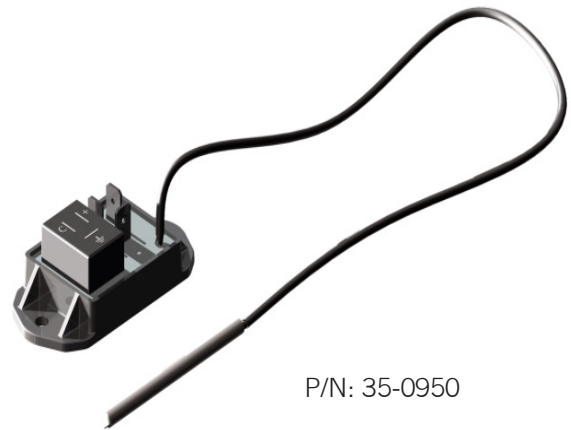

P/N: 35-0950

The EDT has built-in algorithm to protect the A/C system in case of temperature sensor failure.

3. Application and Pin Out

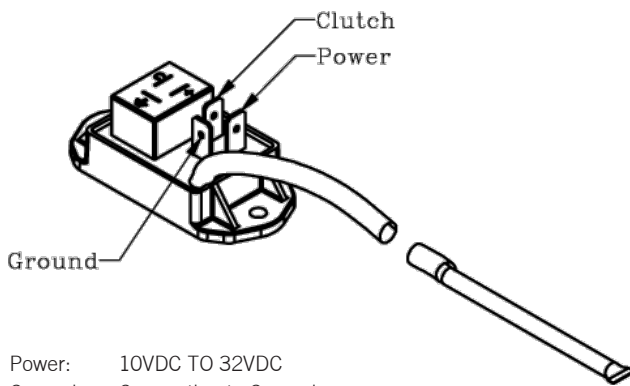
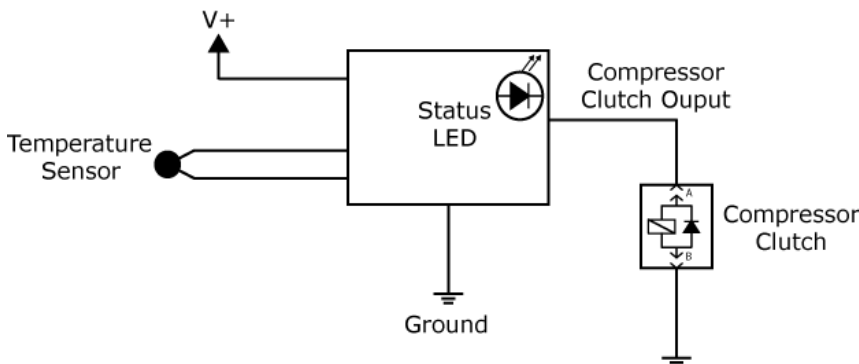

- Power: 10VDC TO 32VDC
- Ground: Connection to Ground
- Clutch: Output connection Compressor Clutch (10 Amps Max)

Electronic De-icing Thermostat (EDT)

4. Diagnostics

In an event of temperature sensor error, the compressor clutch output is turned off and the status light will indicate the type of error detected.

Status LED	Sensor Status
Single blink	Open
Double blink	Short to ground

5. Specifications

Operating Voltage: 10VDC to 32VDC

Voltage Cut in/Cut out Temperature

Cut in: +2°C ±0.4°C

Cut out: -2°C ±0.4°C

Temperature

Storage Temperature: -40°C to +105°C

Operating Temperature: -40°C to +85°C

Clutch Output: 10A Maximum

Electrical Connections:

Connector

Delphi: 02984378 MCC: 31-1029

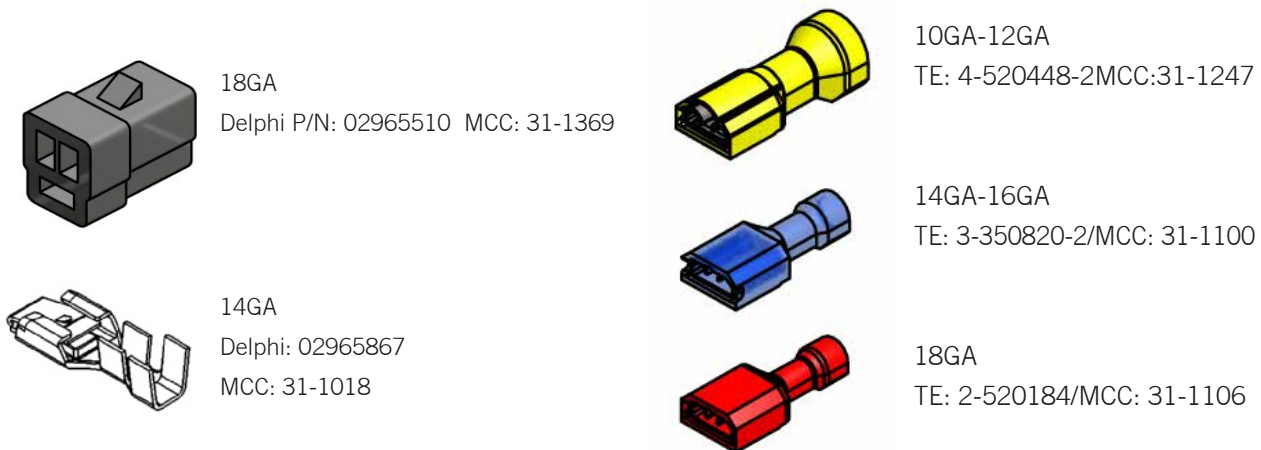

Electronic De-icing Thermostat (EDT)

6. Physical Characteristics and Dimensions

The EDT measures approximately 68 mm long, 32 mm wide and 23 mm high. The printed circuit board is mounted in a plastic case and is encased in a polyurethane potting compound.

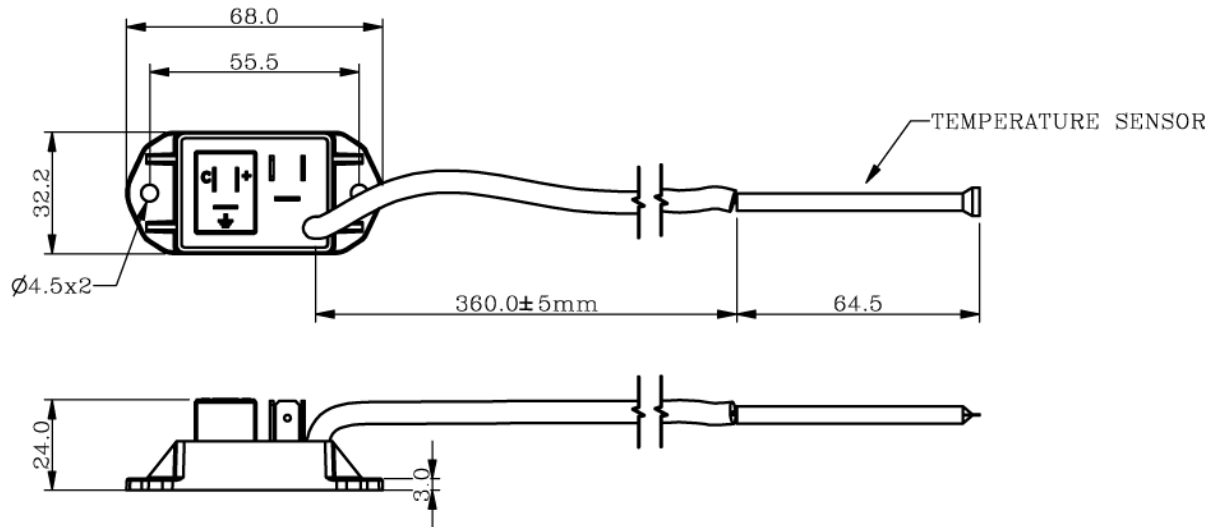

Electronic Actuators

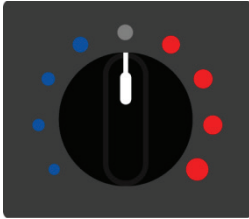

Temperature Control



Flapper Door Control

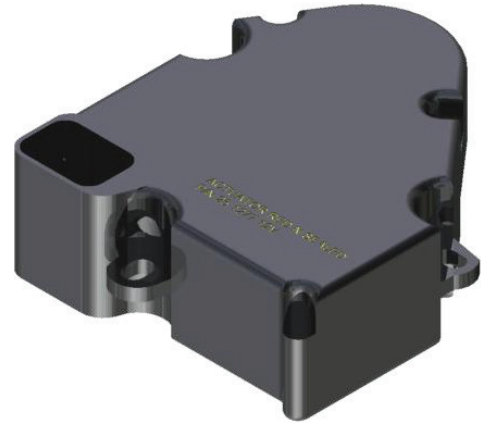

Sealed Type 12V or 24V
P/N: 25-1277 12V
P/N: 25-2660 24V

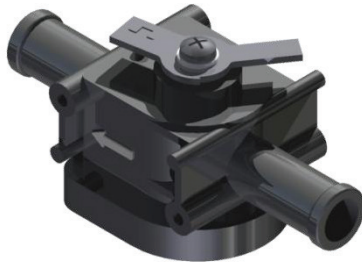

P/N: 26-1021
Water Valve Assembly

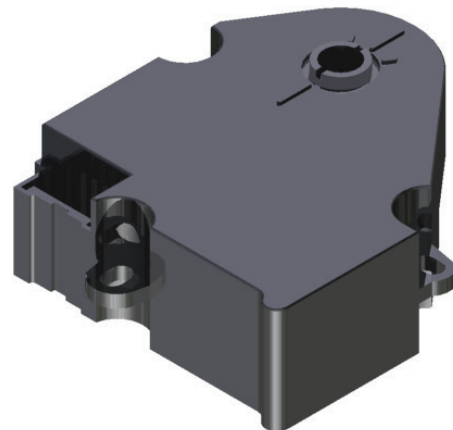

Unsealed type 12V
P/N: 12-1128 12V

Electronic Power Supplies

P/N: 26-1429

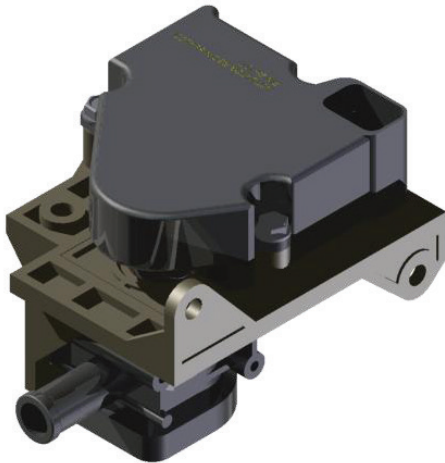

Water valve with sealed actuator

P/N: 26-0652

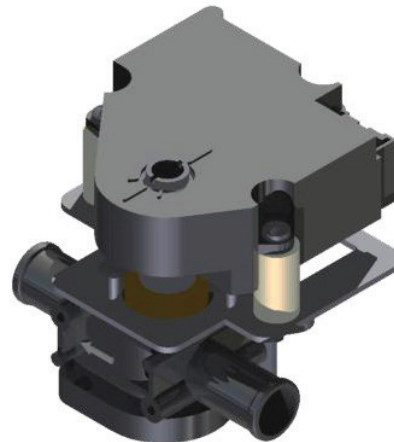

Water valve with unsealed actuator

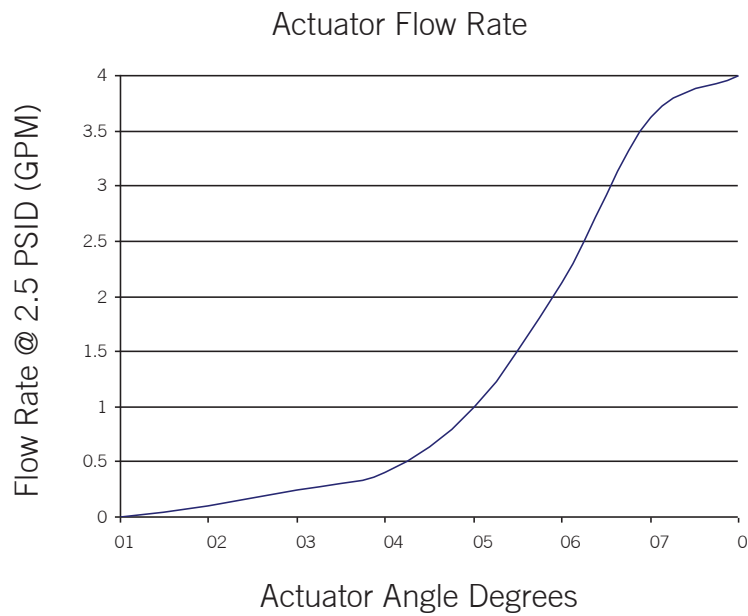

Status Module



P/N: 35-0536

Specifications:

Operating Voltage: 9V DC to 32V DC
 Operating Temperature: -40°C to +85°C (-40°F to 185°F)

Differential Pressure Transducer

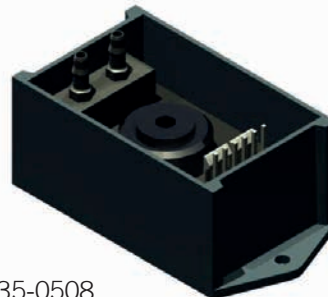

P/N: 35-0508

Specifications:

Input Voltage: 4.8V to 15V DC
 Pressure Range: 0.1 mbar(0.5V) to 10mbar(4.5V)
 Storage Temperature: -40°C to +85°C (-40°F to 185°F)
 Operation Temperature: -20°C to 70°C (-5°F to 160°F)
 Humidity: 0% to 95% RH

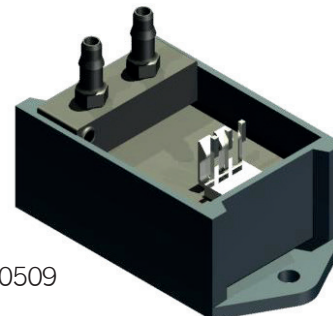

P/N: 35-0509

Electronic Power Supplies

35-0244 and 35-0478 are voltage converters designed to convert 24V DC to 12V DC.

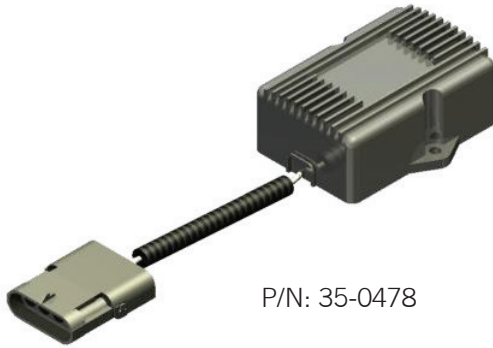

P/N: 35-0478

Specifications:

Input Voltage: 24V DC
 Output Voltage: 14V DC
 Operation Temperature: -40°C to +85°C
 (-40°F to 185°F)

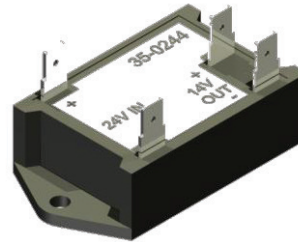

P/N: 35-0244

Specifications:

Input Voltage: 24V DC
 Output Voltage: 14V DC
 Operation Temperature: -40°C to +85°C
 (-40°F to 185°F)

DC to AC converter for EL backlights in control panels.

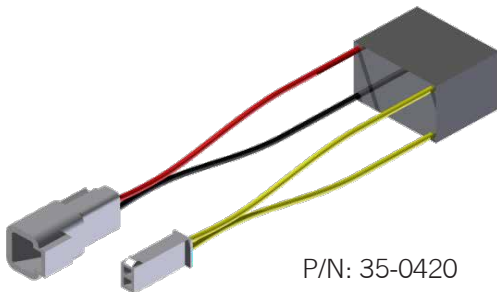

P/N: 35-0420

Specifications:

Input Voltage: 12 DC
 Output Voltage: 120V AC @ 600HZ
 Operation Temperature: -40°C to +85°C
 (-40°F to 185°F)

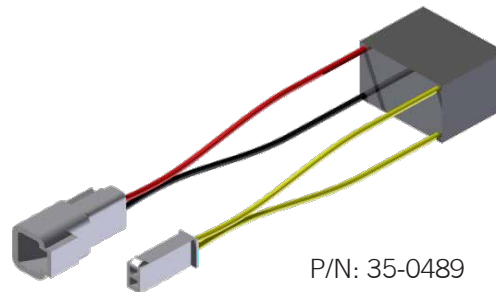

P/N: 35-0489

Specifications:

Input Voltage: 24V DC
 Output Voltage: 120V AC @ 600Hz
 Operation Temperature: -40°C to +85°C
 (-40°F to 185°F)

Coolview

Since the ECC, MVC, Multiplex nodes and Electronic Thermostat are micro controller based, the control algorithm can be customized to each customer's individual requirements.

Each software contains customized climate control algorithm to control different HVAC components

ECC

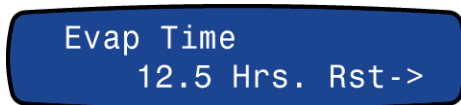

Component running hours



Pressure Switch Trips



Supply Voltage



Temperature Sensor

MVC

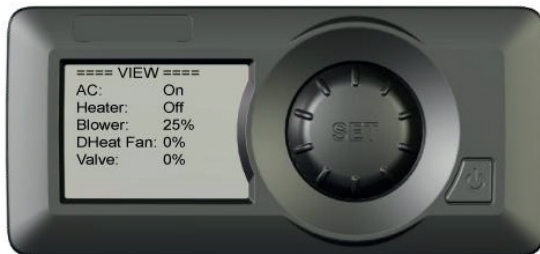

Output Parameter Status



Component Error List

Coolview

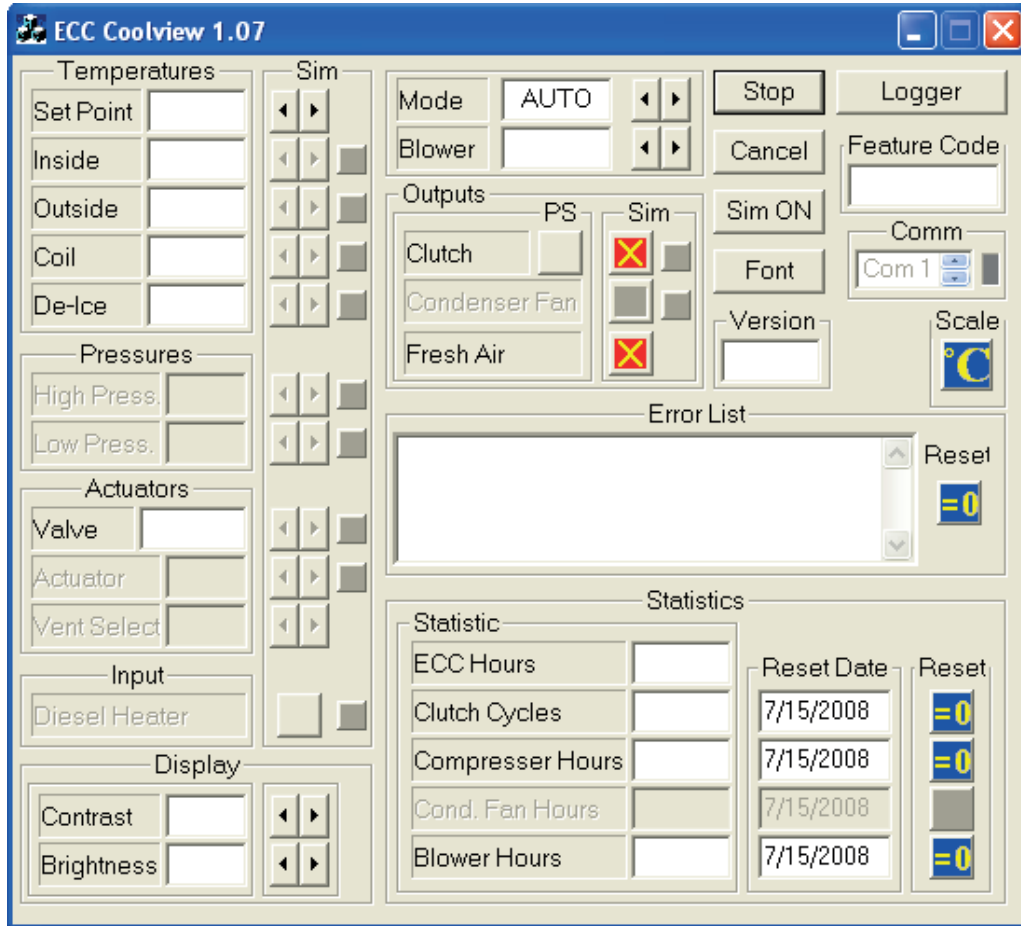

MCC's Coolview is designed to assist in diagnosing, monitoring and troubleshooting a vehicle's HVAC system.

Coolview Displays: Sensor Temperatures
 Status of Inputs and Outputs
 HVAC Mode (Cool, Heat, Defrost, Auto and Diesel Heat)
 Blower Speed, Actuators Position, Display Contrast and Brightness

System History : ECC, Compressor and Blower Hours
 Errors
 Clutch Cycles

ECC Downloader

Using any PC running Windows™ 2000/XP/VISTA/7 platform via RS-232 or USB port, software upgrades can be made. ECC Downloader that can reprogram the ECC while the vehicle is running.

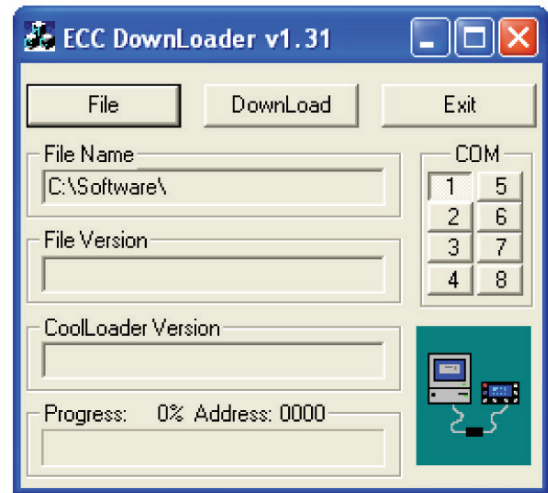

RS-485 Communication

The RS-485 to USB converter is design for communication between a computer and ECC controller via USB port. It is compatible with MCC Coolview and ECC Downloader.



P/N: 35-0735

The RS-485 to RS-232 converter is design for communication between a computer and ECC controller via RS-232 port. It is compatible with MCC Coolview and ECC Downloader. Simple Plug and Play setup requires no special drivers to install.



P/N: 35-0202

Data Logger Downloader

The MCC Data Logger Downloader retrieves data that is saved in the Data Logger's on board memory via RS-485 or USB connection. The saved data can be in Raw or Decoded data format which can be used for troubleshooting and diagnostics.

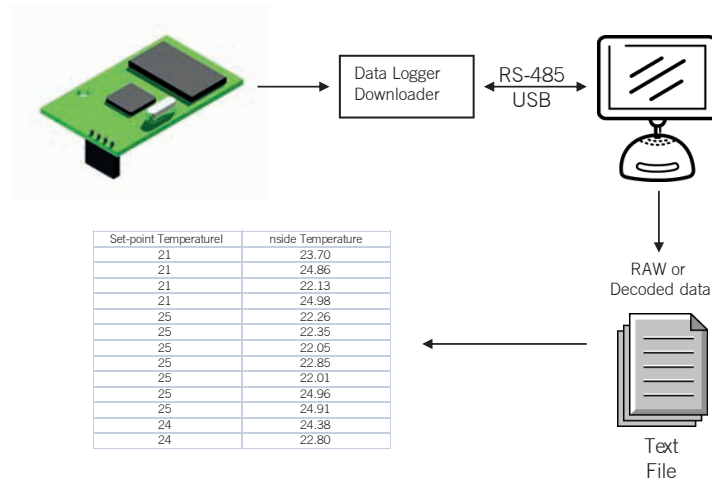

Coolview Fleet Tracking

MCC Coolview Fleet Tracking is a standard ECC with an optional WiFi or 3G GSM transceiver. Coolview Fleet Tracking allows real-time monitoring and diagnostic. Data stored ECC's memory can be downloaded anytime to be analyzed by MCC and local service personnel.

